

Original MINI accessories. (from MotoringFile.com)



Sun guard film for rear side and rear windows

MINI One (R50)

MINI Cooper (R50)

MINI Cooper S (R53)

Retrofit kit no.: 51 46 0 417 834 Sun guard film for rear side and rear windows

Installation time

The installation time is approx. 0.75 hours, but may vary depending on the condition of the car and the equipment in it.

Important information

These installation instructions are primarily designed for use within the MINI dealership organisation as well as by authorised MINI service companies.

In any event, the target group for these installation instructions is specialist personnel trained on MINI cars with the appropriate specialist knowledge.

All work must be completed using the latest MINI repair manuals, circuit diagrams, servicing manuals and work instructions, in a rational order, using the prescribed tools (special tools) and observing current health and safety regulations.

To avoid unnecessary extra work and/or costs, if any installation or function problem occurs, after a brief troubleshooting session (approx. 0.5 hours), please contact the following:

- 1. Either your national subsidiary or your regional office, or**
- 2. The support team via the Aftersales Assistance Portal (ASAP), using the optional technical parts support application.**

Specify the chassis number and the part number of the installed retrofit kit and give a precise description of the problem.

Do not archive the hard copy of these installation instructions since daily updates are made by ASAP!

Pictograms:



 Denotes instructions that draw your attention to dangers.

 Denotes instructions that draw your attention to special features.

 Denotes the end of the instruction or other text.

Installation information

The installation of the side sun guard film is described for the rear right side window. Proceed in the same way for the rear left side window and the rear window.

-  The sun guard film must not be installed at temperatures less than +5°C. ◀
-  The sun guard films are designed to fit the respective windows and molded to the specific window curvature. Hence, the sun guard films are slightly rippled before installation. ◀

Special tools required

Microfiber cloth, MINI recommends Active Fleece, part number: 51 91 0 148 334 or 51 91 0 148 336 (please order separately)





Paper towel

Antistatic duster

Spray bottle 2x

Hot air gun

Customer notes

-  The curing time of the sun guard film is 10 days. The rear window heating must not be switched on during this time. ◀
-  Two weeks after installation, the wedge-shaped outline of the sun guard film should be pressed on again with the thumbs. ◀
-  The accompanying Compulsory National Type Approval for components **G** must be handed over to the customer and must be kept in the vehicle. ◀
-  Observe the legal regulations in other countries. ◀

Contents

Chapter	Page
1. Parts overview.....	4
2. Preparatory work.....	5
3. Installing the sun guard film on the side window.....	6
4. Installing the sun guard film on the rear window.....	7
5. Concluding work.....	8
6. Removal.....	8

1. Parts overview

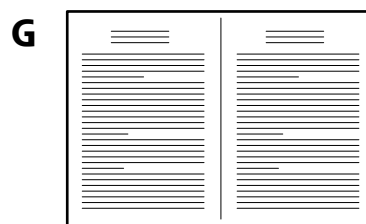
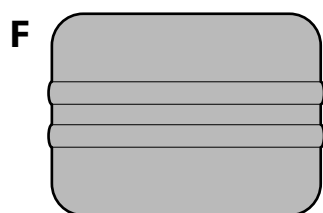
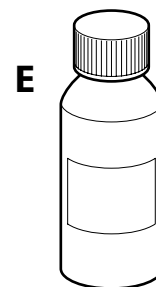
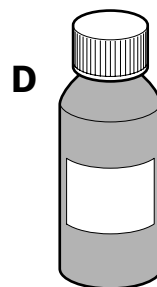
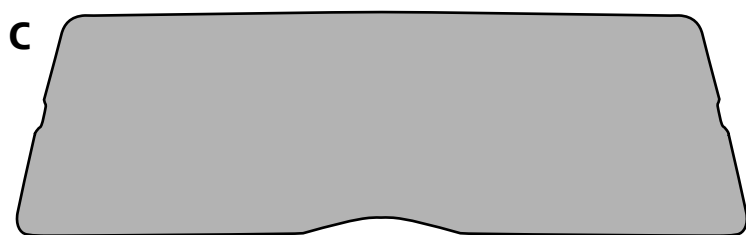
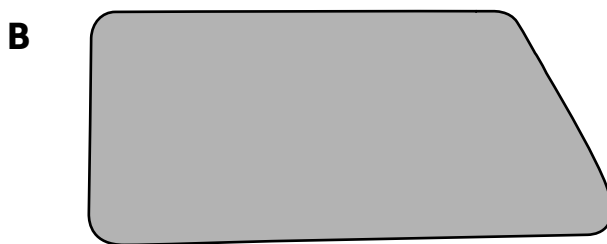
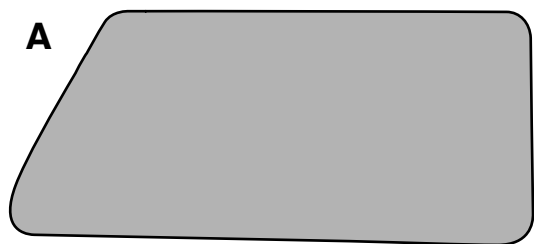

050 0001 M

Legend

- A** Sun guard film, rear left side window
- B** Sun guard film, rear right side window
- C** Sun guard film, rear window

- D** Glass cleaner, blue
- E** Assembly fluid, white
- F** Plastic blade
- G** Compulsory National Type Approval for components

2. Preparatory work

Mix the glass cleaner **D** with 40 ml of water in a mixing ratio of 1:4.

Mix the assembly fluid **E** with 600 ml of water in a mixing ratio of 1:60.

Clean the interior of the car thoroughly before starting work.

Spray the interior trim around the windows extensively with glass cleaner **D** in order to bind the dust.

Clean the windows from the inside with glass cleaner **D**.



If necessary, give the windows a final wipe with an antistatic cloth. ◀



The windows must be completely dry and free of dust, grease and dirt; otherwise this can lead to visible residual contamination of the sun guard films. ◀

3. Installing the sun guard film on the side window

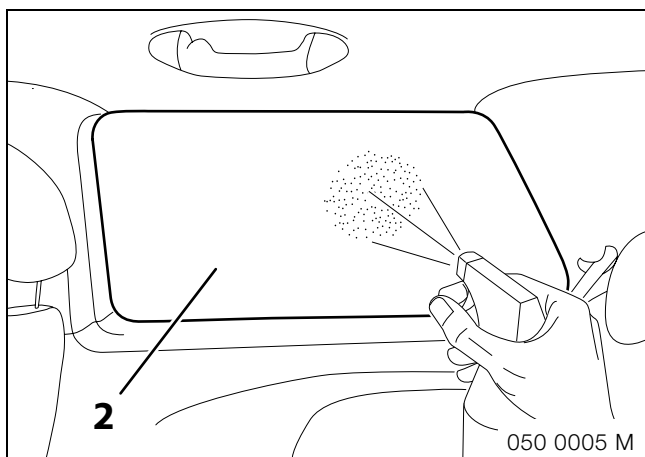

Spray the window (2) where the film is to be glued with assembly fluid **E**.

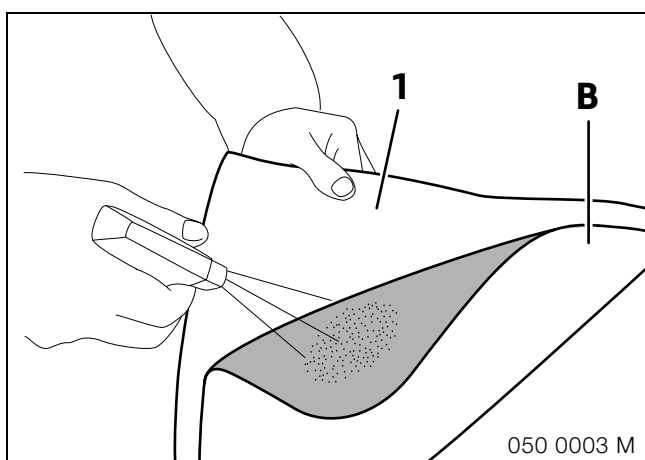

! Do not touch the dry adhesive surface with your hands. ◀

Moisten hands with assembly fluid **E**.

Pull the protective film (1) off the sun guard film **B**. While removing the protective film (1), spray the adhesive surface of the sun guard film **B** with assembly fluid **E**.

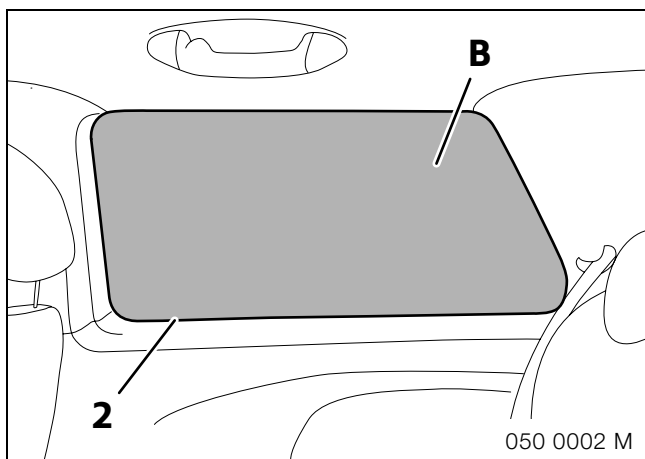

Apply sun guard film **B** to the window (2), aligning it to precisely fit the window on all sides.

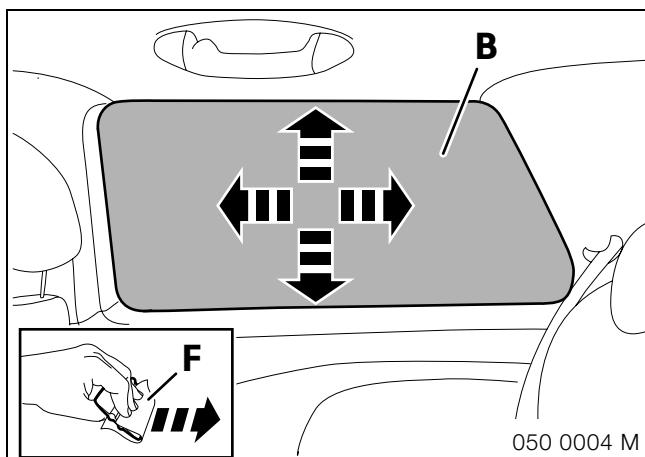

Fold a paper towel around plastic blade **F**.

To smooth out sun guard film **B**, push with plastic blade **F** from the middle of the window outwards as shown (see arrows).

! Do not pull plastic blade **F** as this could damage the sun guard film. ◀

Remove excessive assembly fluid **E** with the microfiber cloth or Active Fleece.

4. Installing the sun guard film on the rear window

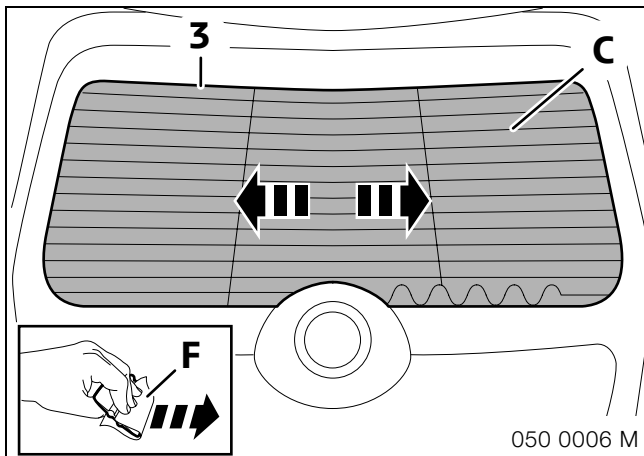

▶ Carry out work steps of sun guard **C** according to the first three pictures of Chapter 3, Installing the sun guard film on the side window. ◀

To smooth out sun guard film **C**, push with plastic blade **F** horizontally from the middle of the window outwards as shown (see arrows).

⚠ Only push plastic blade **F** in the longitudinal direction of the heater wire; otherwise the heater wire could be damaged. ◀

As sun guard film **C** is matched to the contour of the rear screen, this may result in wrinkles in one corner because sun guard film **C** is under tension.

In this case, hold the smoothed out area at the edge by hand and smooth out the wrinkles in a longitudinal direction. This will release the tension.

5. Concluding work

 After installing the sun guard films, park the car in the sun and, if necessary, after a drying period of approx. one hour and using a hot air gun on the lowest setting and at sufficient distance, carefully heat the edges of the two side windows and the rear screen. This will evaporate any residues of assembly fluid **E** between window and sun guard film. ◀

 There must be no creases or kinks after installing the sun guard films. ◀

6. Removal

Side windows

Pull off the sun guard film in one piece if possible. Spray the adhesive residues with glass cleaner and apply the removed sun guard film to the window again.

After approx. 15 minutes, take the sun guard film off again and remove the softened adhesive residue carefully from the windows using a glass scraper or glass plane.

To ensure that all adhesive residues have actually been removed, rub the windows with some denaturated alcohol.

After 1-2 minutes, wipe off any gray colored adhesive residue with paper towels soaked in denaturated alcohol.

Rear window

 Do not use the glass plane to clean the rear window because of the heating wires. ◀

A simple method is:

Spray the fitted sun guard film with glass cleaner and immediately cover with a plastic film (e.g. cling film). Avoid large air bubbles between the films while doing this. Park the car in the sun.

After approx. 30 minutes, with the help of the sun, the glass cleaner will have softened the adhesive on the window. Drive the car back into the workshop.

First remove the plastic film, and then slowly and evenly pull the sun guard film off the window. Any adhesive will remain on the sun guard film.

Wipe off any remaining adhesive residue with paper towels soaked in denaturated alcohol.